

# KT-1号 F 製品図

( JIS A 5371 6A-350 )

**A 型** W = 47.5 kg  
V = 0.0213 m<sup>3</sup>

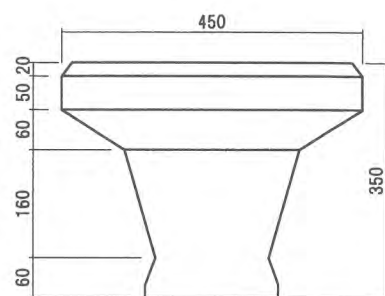
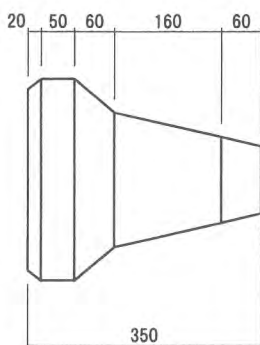
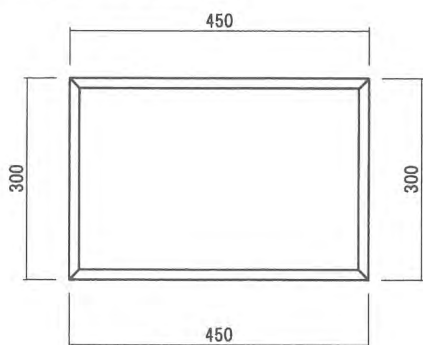

(1 m<sup>2</sup>あたり)胴込め = 0.1907 m<sup>3</sup>

**B 型**

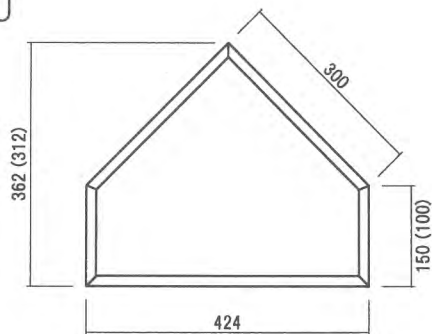

**C 型**

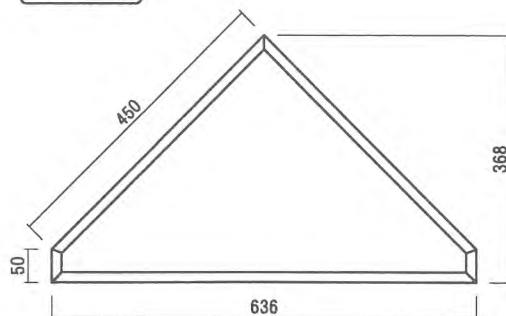

**D 型**

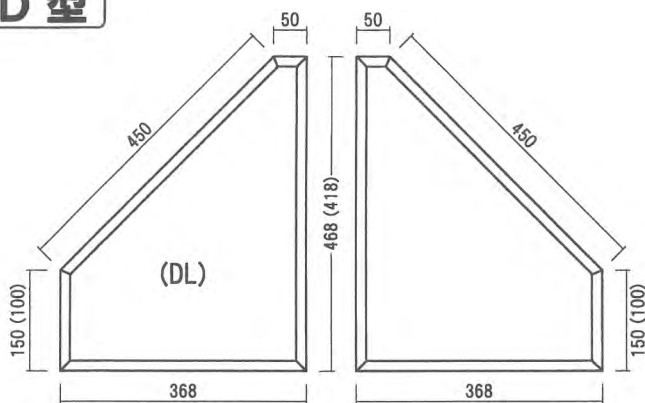

**E 型**

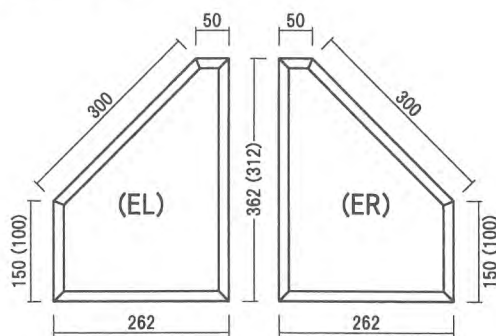

**H 型**

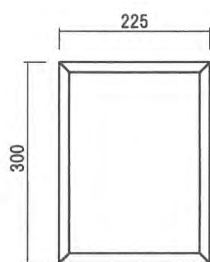

日本産業規格適合性認証工場  
タカコン株式会社

〒252-1108 神奈川県綾瀬市深谷上8-5-18

TEL 0467-78-4085

FAX 0467-76-1233